



# DAV-M

Air Release and Vacuum  
Break Valves

**DAV-M**  
(Metal Air Valves)



## DAV-Metal

### Air Release and Vacuum Break Valves

#### First Operation:

##### Venting air from a filling pipeline

The standard valve allows discharge of trapped air while the system is being filled with liquid. The valve will remain open, even at very high air flow velocity (A), until the liquid has reached the float and lifted it to its closed position (B).

Available for valve models with suffix "K" and "KA".

#### Second Operation:

##### Vacuum Breaking (Air Intake) of a draining pipeline

Decrease or the pressure in the system to negative value and the simultaneous drainage of the valve chamber, forces the floats down, allowing the admittance of air into the pipe, thus preventing negative pressure and possible collapse of the pipe (C).

Available for valve models with suffix "K" and "KA".

#### Third Operation:

##### Release of dissolved air from a pressurized pipeline

Air that is being released from the liquid in the pressurized system or being introduced into the system from open sources and pumping vortices, accumulates in the air release valves located at high places.

The accumulated air forces the liquid out of the valve chamber, so the floating force of the bottom float decreases.

The bottom float then drops, allowing for the trapped air to be vented through the small nozzle at the center of the top float. Then the liquid level rises, the bottom float is lifted and the nozzle closes (D).

Available for valve models with suffix "KA" only.

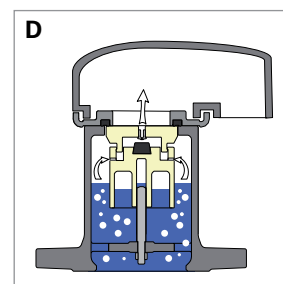
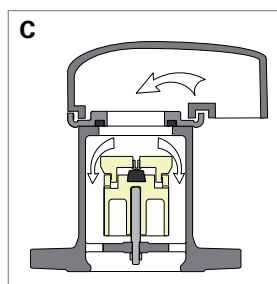
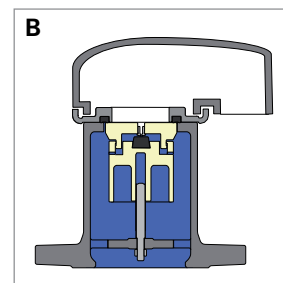
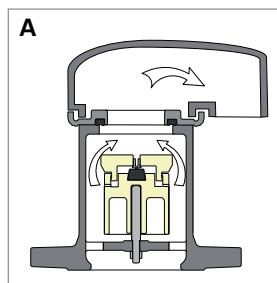

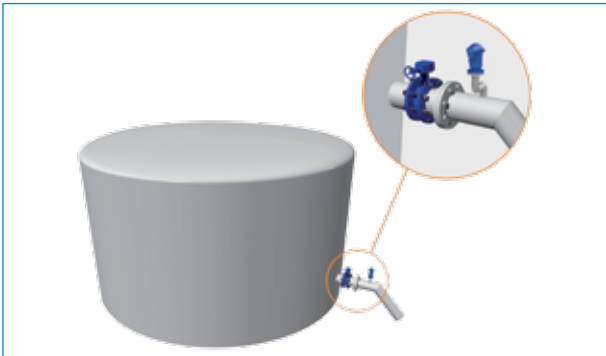

Outlet of reservoir, downstream of the isolation valve



Discharge side of pumps, upstream of a non return valve

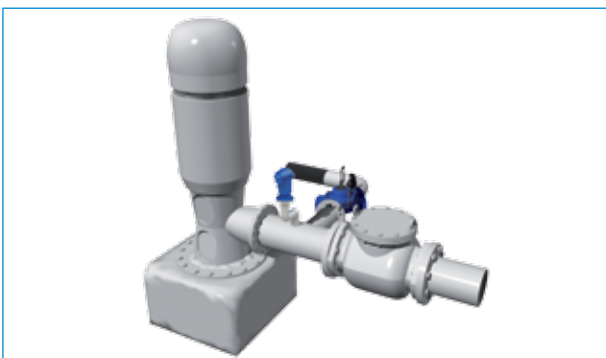

Discharge side of vertical turbine pumps, upstream of a non return valve

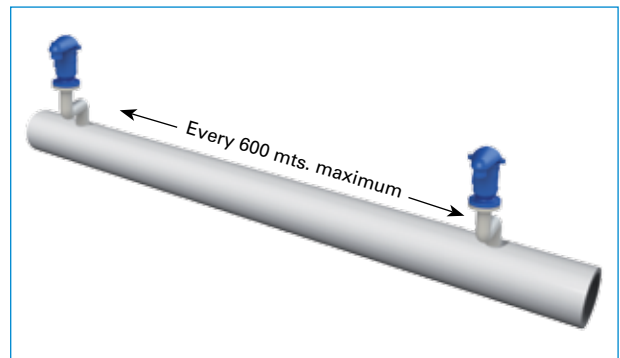

On uniform, long pipe sections: horizontal run, long descents, and long ascents



Negative breaks: increase in a downward slope



Adjacent to a pressure reducing device



Both sides of check-valves, isolating valves or any device that may be closed

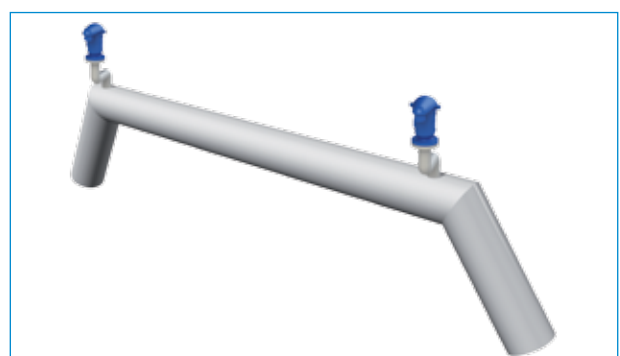

Both sides of canal and bridge crossings

Components

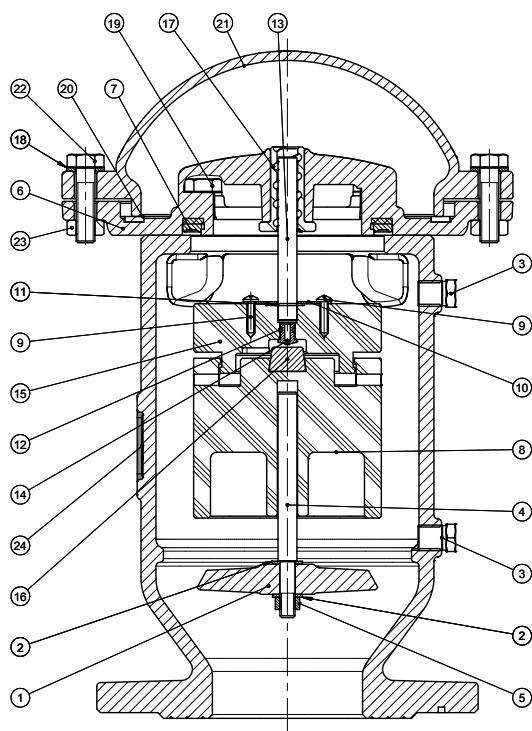

No.	Description	Material	Optional
1	Body	D.I.	Steel A-216 WCB, SST CF8M, NI Aluminium Bronze, S.Duplex
2	Washer	SST	SST 316, S.Duplex
3	Plug	BRS	SST 316, S.Duplex
4	Bottom Guiding Shaft	SST	SST 316, S.Duplex
5	Nut	SST	SST 316, S.Duplex
6	Plate	D.I.	Steel A-216 WCB, SST CF8M, NI Aluminium Bronze, S.Duplex
7	Seal	EPDM	NBR, Viton
8	Float Body	PE-H.D.	
9	Bolt	SST	SST 316, S.Duplex
10	Disc	SST	SST 316, S.Duplex
11	I.D. Plate	AL	SST 316
12	O-Ring 2-009	NBR	EPDM, Viton
13	Top Guiding Shaft	SST	SST 316, S.Duplex
14	Nozzle	SST	SST 316, S.Duplex
15	Float Cover	PE-H.D.	
16	Nozzle Seal	EPDM	NBR, Viton
17	Guiding Insert	POM	
18	Washer	SST	SST 316, S.Duplex
19	Bolt	SST	SST 316, S.Duplex
20	Cover Seal	EPDM	NBR, Viton
21	Cover	D.I.	Steel A-216 WCB, SST CF8M, NI Aluminium Bronze, S.Duplex
22	Bolt	SST	SST 316, S.Duplex
23	Nut	SST	SST 316, S.Duplex

## DAV-MH

### High Capacity Combination and Kinetic Valves

#### Dimensions & Weights

Nom. diameter		Height H		Width W		d-Kinetic orifice area		Approx. shipping Weight	
inch	mm	inch	mm	inch	mm	inch <sup>2</sup>	mm <sup>2</sup>	kg	lbs
2	50	10.7	273.5	9.2	236	3.0	1960	11	24.2
3	80	14	355	12.8	326	7.7	5000	18	39.6
4	100	15.5	395	15.4	393	12.2	7855	30	66.1
6	150	19.1	486.5	24.4	621	27.4	17670	60	132.3
8	200	22.3	567	19.8	503	48.7	31415	100	220.5
10	250	29.6	752	27.8	707.5	76	49090	200	441

Connections: ISO, ANSI, BS, JIS flanges, BSP, NPT threads (50mm valves only)

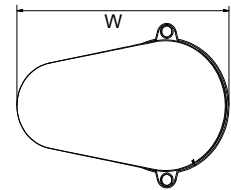
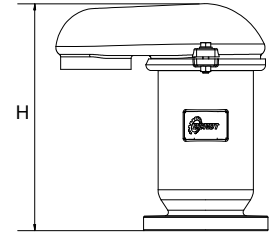

#### Specifications

<b>Nominal sizes</b>	2" / 50mm to 10" / 250mm
<b>Pressure rating</b>	PN16 (250 psi), PN25 (350 psi) and PN40 (580 psi)
<b>Minimal pressure for drip-tight sealing</b>	0.2 bar
<b>Temp. Range</b>	Operating: 0-60°C / 32-140°F
	Storage: -10-70°C / 15-160°F

#### Aero-Dynamic Performance

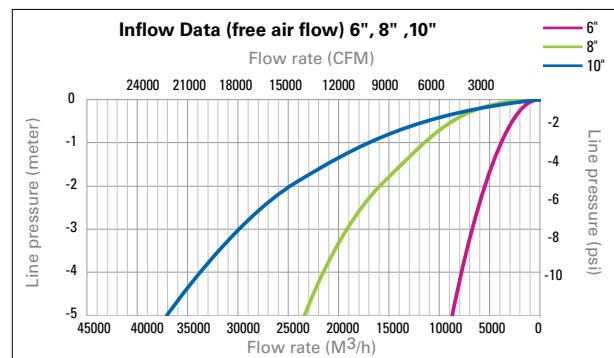
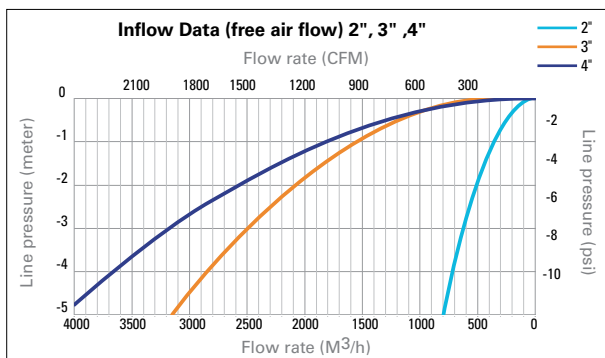
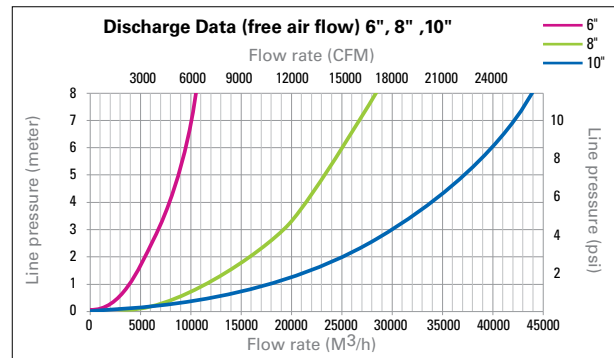
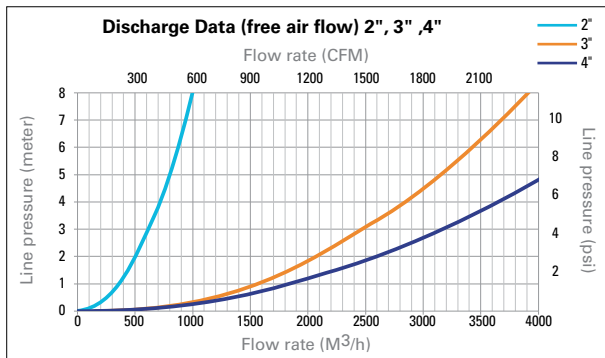

Small-orifice ('Automatic') discharge flow

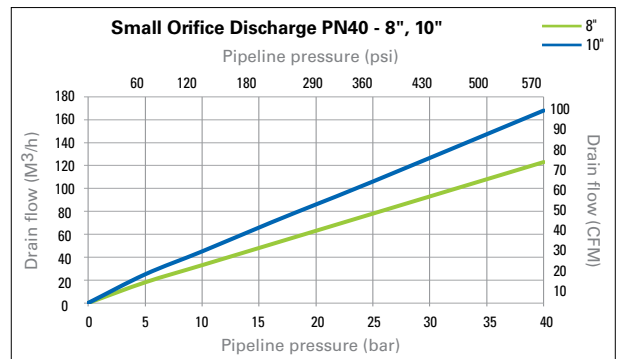
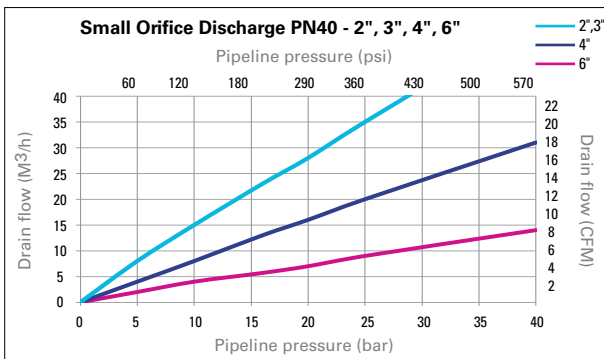
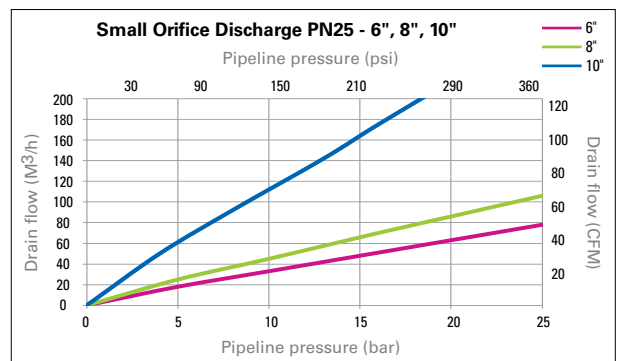
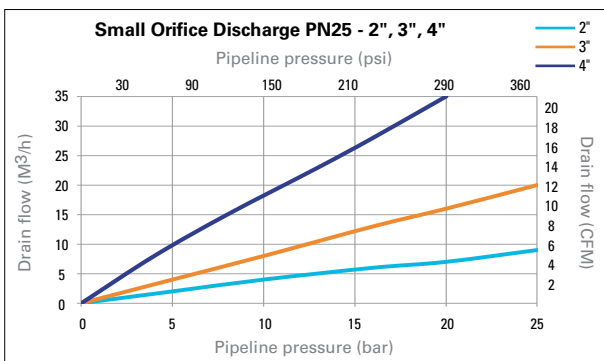
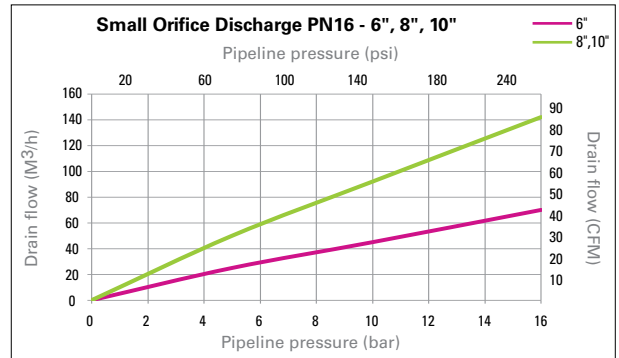
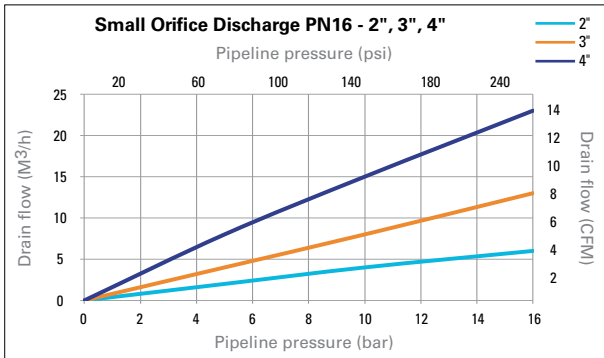

## DAV-MS Combination and Kinetic Valves

### Dimensions & Weights

Nom. diameter		Height H		Width W		d-Kinetic orifice area		Approx. shipping Weight	
inch	mm	inch	mm	inch	mm	inch <sup>2</sup>	mm <sup>2</sup>	kg	lbs
3	80	10.9	277	9.2	235	3.0	1960	12	26.4
4	100	14	356	12.8	326	7.8	5025	22	48.4
6	150	15.5	395	15.5	395	12.2	7855	36	79
8	200	17.8	452	24.4	621	27.4	17670	59	130
10	250	22	558	19.8	503	48.7	31415	100	220.5
12	300	30.5	775	27.8	707.5	76.1	49090	210	463

Connections: ISO, ANSI, BS, JIS flanges, BSP, NPT threads (50mm valves only)

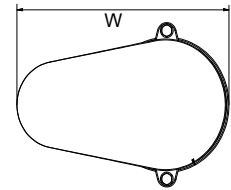
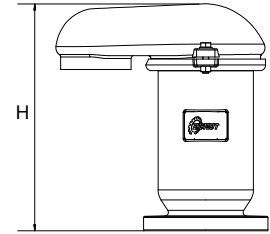

### Specifications

<b>Nominal sizes</b>	3" / 80mm to 12" / 300mm
<b>Pressure rating</b>	PN16 (250 psi), PN25 (350 psi) and PN40 (580 psi)
<b>Minimal pressure for drip-tight sealing</b>	0.2 bar
<b>Temp. Range</b>	Operating: 0-60°C / 32-140°F
	Storage: -10-70°C / 15-160°F

### Aero-Dynamic Performance

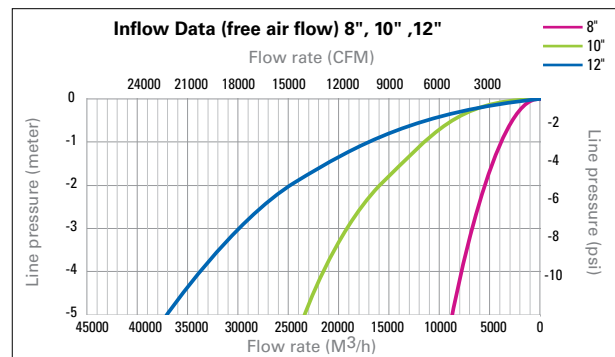
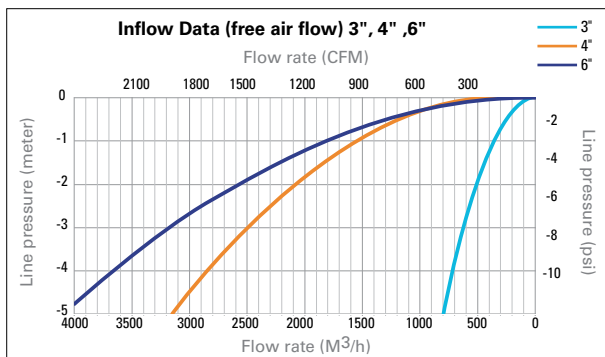
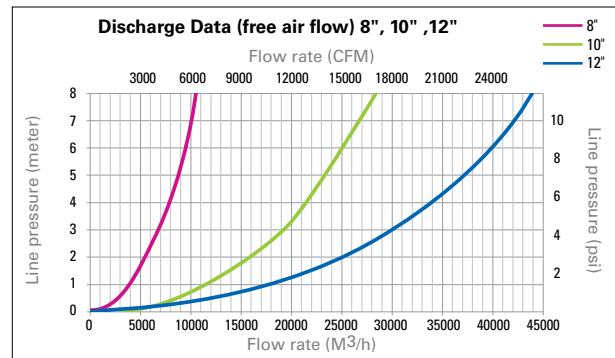
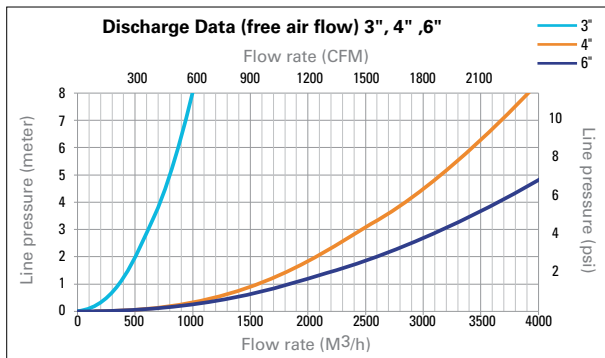



Small-orifice ('Automatic') discharge flow

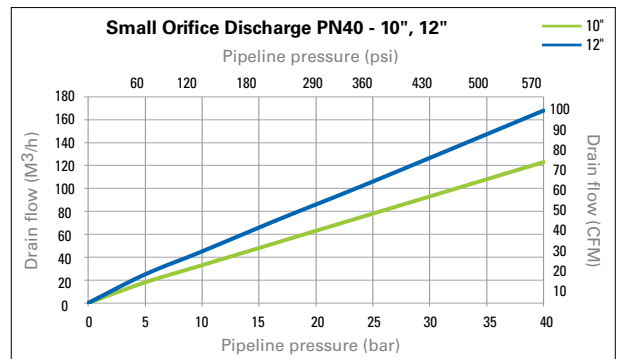
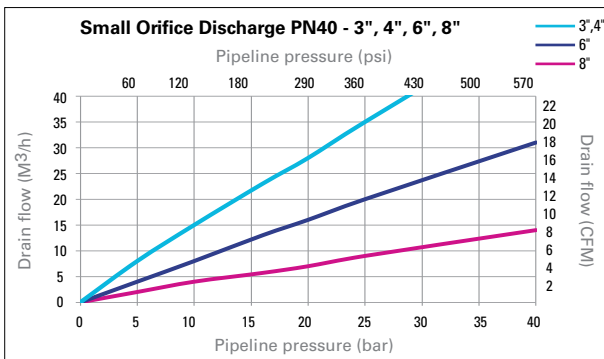
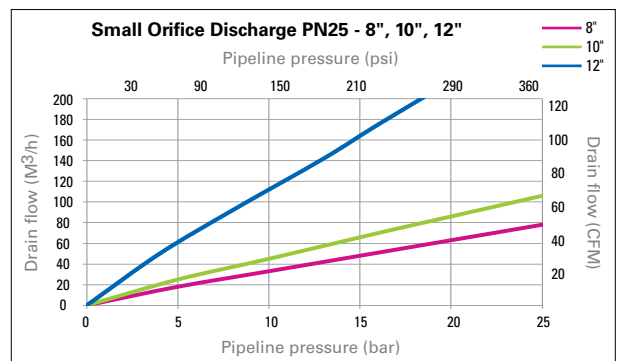
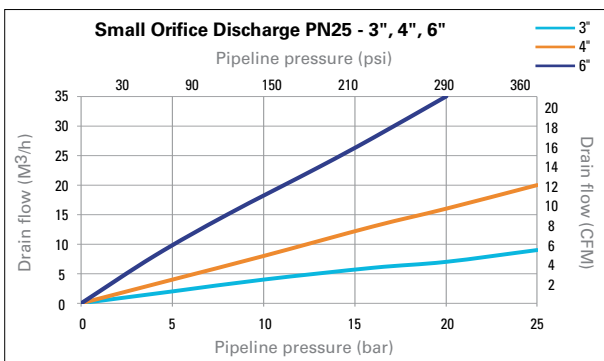
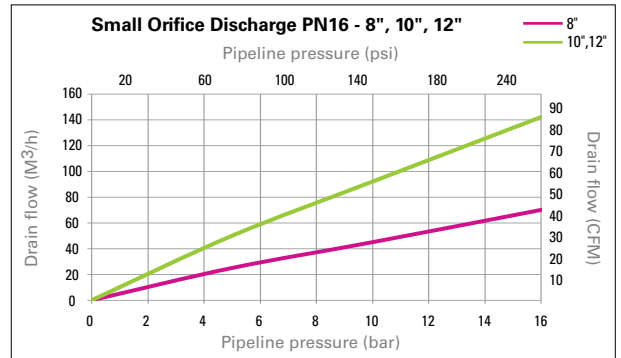
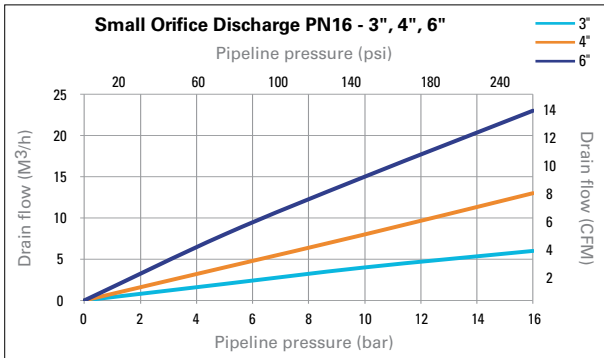



## DAV-M-SA

### Surge Arresting Device for DAV valves

#### Features

- **Surge Arresting** – Automatically prevents water hammer pressure surges associated with air release valves operation.
- **Optimum performance** – Air outlet can be adjusted according to surge analysis results, on site to a required aero-dynamic performance. The SA addition is assembled on user selected valves only (at local high elevated points). The flow through other valves remains unrestricted.
- **Simplicity** – Can be easily assembled on any of Dorot's DAV-M series air valves.
- **Reliability** – Simple, durable mechanism, fabricated from high grade materials. Can be serviced without having to put the air valve out of service.

#### Function

When air is admitted into the pipe, an in "Air Pocket" is created in the local high points where the Air / Vacuum valve is located.

The returning flow re-fills the "pocket".

Too-high velocity of the approaching water column may generate a pressure surge when it reaches the valve.

#### Operation of the SA addition

##### Air venting

The Surge Arrestor addition of "DAV-M" valves limits the air outflow, when the escaping air velocity exceeds a threshold value.

This optional addition creates a temporary, slow closing "Air Cushion" that decelerates the water velocity, preventing water hammer effect.

Adjustment of the air outflow can be done by plugging or un-plugging a set of bores in the SA adjustment plate (see pictures right side).

##### Vacuum Breaking (Air Intake)

Decrease or the pressure in the system to negative value and the simultaneous drainage of the valve chamber, forces the floats down, allowing the admittance of air into the pipe. The SA disc is in its low position, allowing unrestricted air flow into the system.

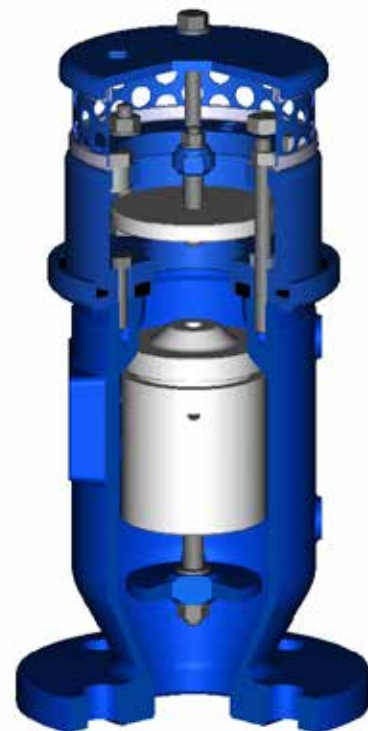

Aero Dynamic Performance > Free air outflow

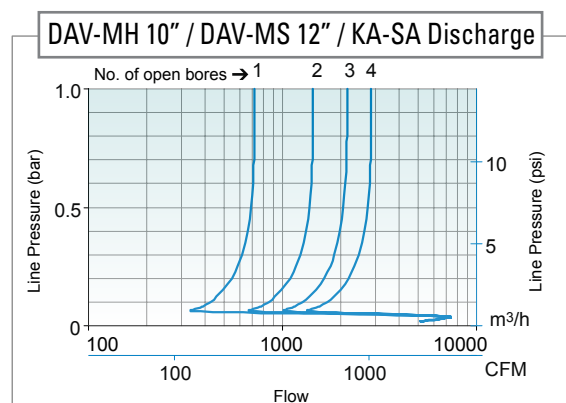
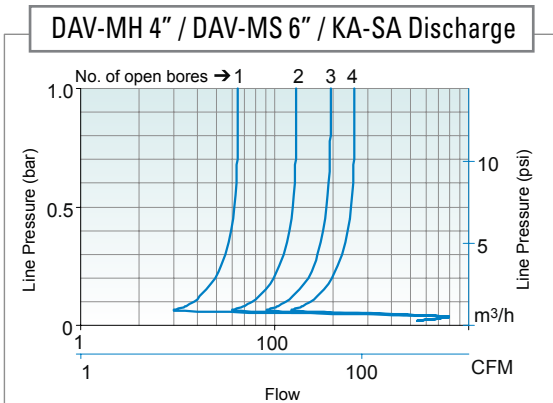
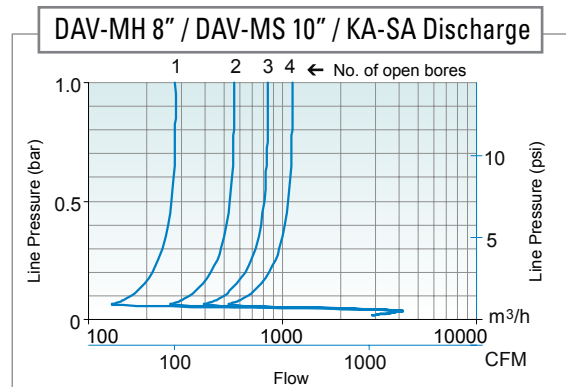
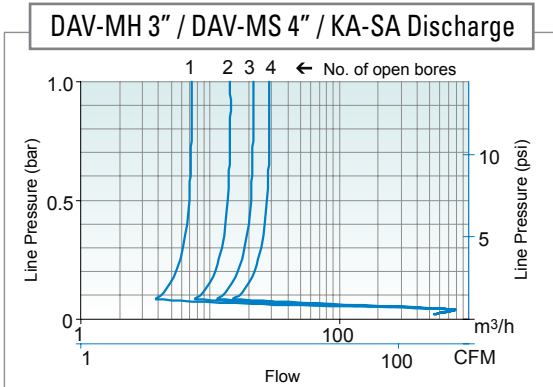
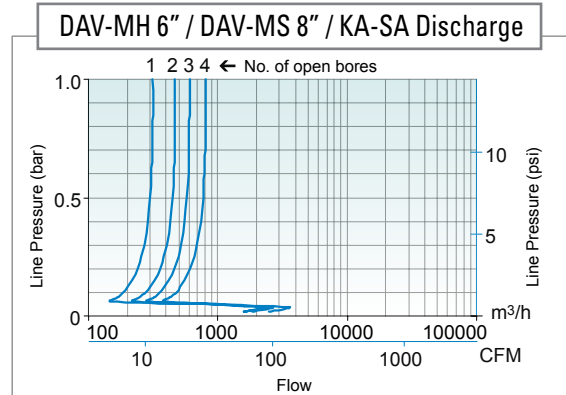
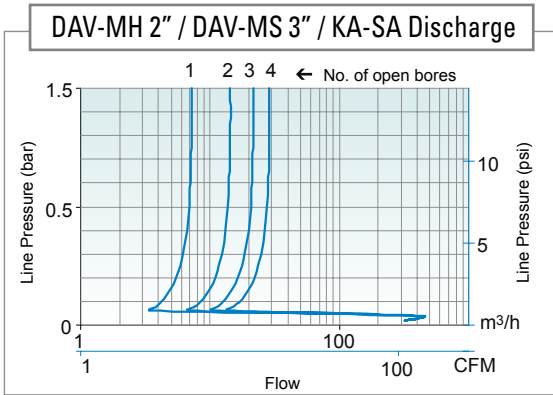

### Ordering guide:

Ordering data		Ordering code								Ordering data	
	DAV	<input type="checkbox"/>	<input type="checkbox"/>	<input type="checkbox"/>	<input type="checkbox"/>	<input type="checkbox"/>	<input type="checkbox"/>	<input type="checkbox"/>	<input type="checkbox"/>		
<b>Material</b>			↑	↑	↑	↑	↑	↑	<b>Pressure rating</b>		
Ductile Iron (standard)	→	M							PN16	←	PN16 / 250psi
Other (SST, NAB...)	→	C							PN25	←	PN25 / 360psi
<b>Capacity</b>									PN40	←	PN40 / 540psi
High (nominal orifice size)	→	H							<b>Optional Addition</b>		
Standard	→	S							SA	←	Surge Arrestor
<b>External high-capacity air-release</b>									<b>Function</b>		
No	→	-							KA	←	Combination
Yes	→	A							K	←	Kinetic
<b>Size</b>									<b>Connection Standard*</b>		
2" / 50 mm (available in 'H' version only)	→				2	ISO16, 25, 40			←		ISO PN-16, 25, 40
3" / 80 mm	→				3	AN150, 300			←		ANSI 150, 300
4" / 100 mm	→				4	BSP			←		BSP**
6" / 150 mm	→				6	NPT			←		NPT**
8" / 200 mm	→				8						
10" / 250 mm	→				10						
12" / 300 mm (available in 'S' version only)	→				12						

\* Other flange-standards such as JIS, AS, ABNT etc are available upon demand

\*\* BSP and NPT thread-connections are available for 2" \ 50mm only

### Example:

DAV	M	H	-	4	AN300	KA	SA	PN40
-----	---	---	---	---	-------	----	----	------

Dorot Metal air-valve, size 4" (100mm), ANSI 300 Combination Valve with Surge Arrestor, Pressure Rated 40 bar (540psi)



**Innovation**  
Innovation

**Expertise**  
Expertise

**Reliability**  
Reliability



Hundreds of companies in the industrial, civil engineering, municipal and agricultural sectors around the world have chosen DOROT's innovative and field-proven technologies. Since its establishment in 1946, DOROT leads the valves market with continued innovation, uncompromising excellence and firm commitment to its customers, consulting and supporting them through all stages of a project and overcoming challenges in R&D, design, implementation, and maintenance.



[www.dorot.com](http://www.dorot.com)